

Standard Lengths : 2 Metres

Prices do not include 'C' Profiles.

For other sizes, grades or colours
consult our Technical department.

DISCOUNTS

| | |
|----------|------------|
| 1 - 9 | List Price |
| 10 - 49 | - 20% |
| 50 - 100 | - 50% |

without C Section Slots

| PART NUMBER | Finished Size | | | | PRICE PER METRE |
|--------------|---------------|----|------|------|-----------------|
| | B | H | b | h | |
| TDCR5.0RM5 | 20 | 10 | 5.5 | 3.0 | £43.86 |
| TDCR6.3RM6 | 20 | 10 | 7.0 | 3.5 | £43.86 |
| TDCR8.0RM8 | 20 | 12 | 8.5 | 4.5 | £45.35 |
| TDCR9.5RM10 | 25 | 15 | 12.0 | 6.0 | £50.27 |
| TDCR12.5RM12 | 30 | 20 | 13.0 | 6.5 | £58.33 |
| TDCR15.0RM15 | 35 | 25 | 15.5 | 8.0 | £68.04 |
| TDCR18.0RM18 | 40 | 25 | 18.5 | 9.5 | £72.20 |
| TDCR20.0RM20 | 45 | 30 | 20.5 | 10.5 | £84.39 |

with C Section Slots

| PART NUMBER | Finished Size | | | | | C Profile | PRICE PER METRE |
|----------------|---------------|----|------|------|------|-----------|-----------------|
| | B | H | b | h | Hc | | |
| TDCR5.0RM50C | 20 | 10 | 5.5 | 3.0 | 15.0 | TDC 2010 | £80.10 |
| TDCR6.3RM60C | 20 | 15 | 7.0 | 3.5 | 18.0 | TDC 2010 | £83.97 |
| TDCR8.0RM80C | 20 | 15 | 8.5 | 4.5 | 18.0 | TDC 2010 | £83.97 |
| TDCR9.5RM100C | 25 | 15 | 12.0 | 6.0 | 20.0 | TDC 2812 | £86.52 |
| TDCR12.5RM120C | 28 | 15 | 13.0 | 6.5 | 20.0 | TDC 2812 | £88.00 |
| TDCR15.0RM150C | 33 | 20 | 15.5 | 8.0 | 25.0 | TDC 3818 | £96.57 |
| TDCR18.0RM180C | 38 | 20 | 18.5 | 9.5 | 25.0 | TDC 3818 | £99.85 |
| TDCR20.0RM200C | 38 | 25 | 20.5 | 10.5 | 30.0 | TDC 3818 | £106.70 |

Materials

Belt Guides for V-Belts

STD : Polyethylene (U.H.M.W.Pe) Green DIN 2215

ALTERNATIVE : 1000 Black Antistatic

TDC

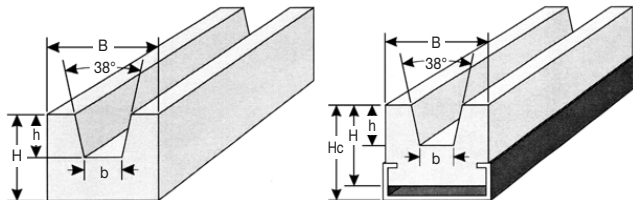

Standard Lengths : 2 Metres

Prices do not include 'C' Profiles.

For other sizes, grades or colours consult our Technical department.

without C Section Slots

DISCOUNTS

| | |
|----------|------------|
| 1 - 9 | List Price |
| 10 - 49 | - 20% |
| 50 - 100 | - 50% |

| PART NUMBER | B | Finished Size | | | PRICE PER METRE |
|-------------|----|---------------|------|------|-----------------|
| | | H | b | h | |
| TDCR8F | 20 | 10 | 5.0 | 3.5 | £44.30 |
| TDCR10Z | 20 | 10 | 6.5 | 4.5 | £44.30 |
| TDCR13A | 20 | 12 | 8.5 | 6.0 | £44.30 |
| TDCR17B | 30 | 15 | 10.5 | 8.0 | £44.30 |
| TDCR20G | 30 | 20 | 12.5 | 9.0 | £59.23 |
| TDCR22C | 35 | 20 | 14.0 | 10.5 | £62.60 |
| TDCR25H | 40 | 25 | 15.5 | 12.0 | £73.19 |
| TDCR32D | 50 | 30 | 20.0 | 16.0 | £90.34 |
| TDCR40E | 60 | 35 | 25.0 | 21.0 | £111.04 |

with C Section Slots

| PART NUMBER | B | Finished Size | | | C Profile | PRICE PER METRE |
|-------------|----|---------------|------|------|-----------|-----------------|
| | | H | b | h | | |
| TDCR8FOC | 20 | 10 | 5.0 | 3.5 | TDC 2010 | £82.05 |
| TDCR10ZOC | 20 | 15 | 6.5 | 4.5 | TDC 2010 | £82.05 |
| TDCR13AOC | 25 | 18 | 8.5 | 6.0 | TDC 2012 | £82.05 |
| TDCR17BOC | 30 | 18 | 10.5 | 8.0 | TDC 2812 | £82.05 |
| TDCR20GOC | 30 | 18 | 12.5 | 9.0 | TDC 2812 | £99.95 |
| TDCR22COC | 35 | 25 | 14.0 | 10.5 | TDC 3818 | £106.21 |
| TDCR25HOC | 40 | 25 | 15.5 | 12.0 | TDC 3818 | £110.26 |
| TDCR32DOC | 60 | 35 | 20.0 | 16.0 | TDC 3024 | £148.26 |
| TDCR40EOC | 60 | 35 | 25.0 | 21.0 | TDC 3024 | £148.26 |

Unit 14, Foxwood Ind. Park, Foxwood Rd. Chesterfield, Derbyshire S41 9RN

Telephone +44(0)1246 268080 Fax +44(0)1246 260003



12.133

Pulleys & Belts TDC

Belt Guides for Flat & Timing Belts Materials

STD : Polyethylene (U.H.M.W.Pe) Green

TDC

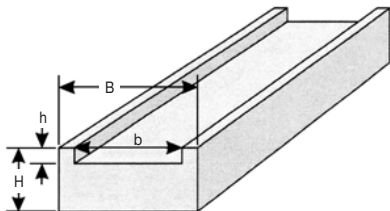

Standard Lengths : 2 Metres

Prices do not include 'C' Profiles.

For other sizes, grades or colours
consult our Technical department.

Pulleys & Belts TDC

DISCOUNTS

| | |
|----------|------------|
| 1 - 9 | List Price |
| 10 - 49 | - 20% |
| 50 - 100 | - 50% |

without C Section Slots

| PART NUMBER | Finished Size | | | h | PRICE PER METRE |
|-------------|---------------|----|-----|-----|-----------------|
| | B | H | b | | |
| TDC5BG10 | 20 | 15 | 12 | 1.5 | £47.72 |
| TDC5BG16 | 28 | 15 | 18 | 1.5 | £51.77 |
| TDC5BG20 | 30 | 15 | 22 | 1.5 | £52.79 |
| TDC5BG25 | 38 | 20 | 27 | 1.5 | £63.61 |
| TDC5BG32 | 42 | 20 | 34 | 1.5 | £66.41 |
| TDC5BG50 | 60 | 25 | 52 | 1.5 | £88.98 |
| TDC10BG20 | 28 | 15 | 22 | 3.5 | £51.77 |
| TDC10BG25 | 38 | 20 | 27 | 3.5 | £63.61 |
| TDC10BG32 | 42 | 20 | 34 | 3.5 | £66.41 |
| TDC10BG50 | 60 | 25 | 52 | 3.5 | £88.98 |
| TDC10BG75 | 87 | 25 | 77 | 3.5 | £111.60 |
| TDC10BG100 | 112 | 25 | 102 | 3.5 | £132.53 |
| TDC10BG150 | 162 | 25 | 152 | 3.5 | £174.39 |
| TDC20BG25 | 38 | 20 | 27 | 6.5 | £63.61 |
| TDC20BG32 | 42 | 20 | 34 | 6.5 | £66.41 |
| TDC20BG50 | 60 | 25 | 52 | 6.5 | £88.92 |
| TDC20BG75 | 87 | 25 | 77 | 6.5 | £111.60 |
| TDC20BG100 | 112 | 25 | 102 | 6.5 | £132.53 |
| TDC20BG150 | 162 | 25 | 152 | 6.5 | £174.39 |

12.134



Unit 14, Foxwood Ind. Park, Foxwood Rd. Chesterfield, Derbyshire S41 9RN
Telephone +44(0)1246 268080 Fax +44(0)1246 260003

Materials **Belt Guides** for Flat & Timing Belts

STD : Polyethylene (U.H.M.W.Pe) Green DIN 2215

ALTERNATIVE : 1000 Black Antistatic

TDC

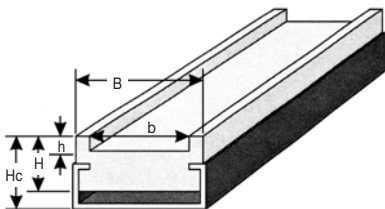

Standard Lengths : 2 Metres

Prices do not include 'C' Profiles.

For other sizes, grades or colours consult our Technical department.

DISCOUNTS

| | |
|----------|------------|
| 1 - 9 | List Price |
| 10 - 49 | - 20% |
| 50 - 100 | - 50% |

with C Section Slots

| PART NUMBER | Finished Size | | | | | C Profile | PRICE PER METRE |
|-------------|---------------|----|-----|-----|------|-----------|-----------------|
| | B | H | b | h | Hc | | |
| TDC5BG10C | 20 | 15 | 12 | 1.5 | 17.5 | TDC 2010 | £83.97 |
| TDC5BG16C | 28 | 15 | 18 | 1.5 | 18.0 | TDC 2812 | £87.91 |
| TDC5BG20C | 30 | 15 | 22 | 1.5 | 18.0 | TDC 2812 | £89.01 |
| TDC5BG25C | 38 | 20 | 27 | 1.5 | 25.0 | TDC 3818 | £99.85 |
| TDC5BG32C | 42 | 20 | 34 | 1.5 | 25.0 | TDC 3818 | £102.58 |
| TDC5BG50C | 60 | 25 | 52 | 1.5 | 30.0 | TDC 6020 | £125.18 |
| TDC10BG20C | 28 | 15 | 18 | 3.5 | 18.0 | TDC 2812 | £87.91 |
| TDC10BG25C | 38 | 20 | 27 | 3.5 | 25.0 | TDC 3818 | £99.85 |
| TDC10BG32C | 40 | 20 | 34 | 3.5 | 25.0 | TDC 3818 | £102.58 |
| TDC10BG50C | 60 | 25 | 52 | 3.5 | 30.0 | TDC 6020 | £125.18 |
| TDC20BG25C | 38 | 20 | 27 | 6.5 | 28.0 | TDC 3818 | £99.85 |
| TDC20BG32C | 42 | 20 | 34 | 6.5 | 28.0 | TDC 3818 | £102.58 |
| TDC20BG50C | 60 | 25 | 52 | 6.5 | 30.0 | TDC 6020 | £125.18 |
| TDC20BG75C | 87 | 25 | 77 | 6.5 | 30.0 | TDC 2175 | £147.83 |
| TDC20BG100C | 112 | 25 | 102 | 6.5 | 30.0 | TDC 21100 | £168.75 |
| TDC20BG150C | 162 | 25 | 152 | 6.5 | 30.0 | TDC 21125 | £210.64 |

Unit 14, Foxwood Ind. Park, Foxwood Rd. Chesterfield, Derbyshire S41 9RN

Telephone +44(0)1246 268080 Fax +44(0)1246 260003



12.135

Pulleys & Belts
TDC

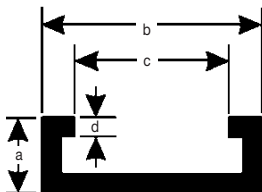

Standard Lengths : 2 Metres

Other lengths and types available on request.

For further information, please contact our Sales department

DISCOUNTS

| | |
|----------|------------|
| 1 - 9 | List Price |
| 10 - 49 | - 20% |
| 50 - 100 | - 50% |

| PART NUMBER | Finished Size | | | | Material | PRICE PER METRE |
|-------------|---------------|----|----|-----|------------|-----------------|
| | a | b | c | d | | |
| TDC2010 | 10 | 20 | 10 | 1.5 | Galvanised | £7.27 |
| TDC2010-SS | 10 | 20 | 10 | 1.5 | Stainless | £25.61 |
| TDC2812 | 12 | 28 | 14 | 2.0 | Galvanised | £14.08 |
| TDC2812-SS | 12 | 28 | 14 | 2.0 | Stainless | £43.49 |
| TDC3818 | 18 | 38 | 22 | 2.5 | Galvanised | £18.49 |
| TDC3818-SS | 18 | 38 | 22 | 2.5 | Stainless | £83.11 |
| TDC3024 | 24 | 30 | 20 | 1.5 | Galvanised | £20.77 |
| TDC3024-SS | 24 | 30 | 20 | 1.5 | Stainless | £53.75 |
| TDC4540 | 40 | 45 | 31 | 2.0 | Galvanised | £28.29 |
| TDC4540-SS | 40 | 45 | 31 | 2.0 | Stainless | £127.14 |
| TDC6020 | 20 | 60 | 36 | 2.5 | Galvanised | £31.73 |
| TDC6020-SS | 20 | 60 | 36 | 2.5 | Stainless | £136.94 |

Materials **Guide Rails** for Simplex Chains

STD : Polyethylene (U.H.M.W.Pe) Green DIN 8187

ALTERNATIVE : Stainless Steel

TDC

TAG V 15

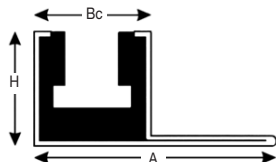

TAG

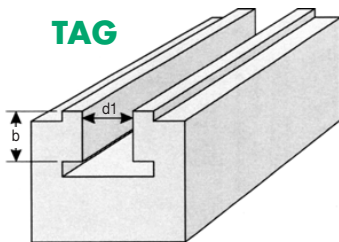

TAG G 14

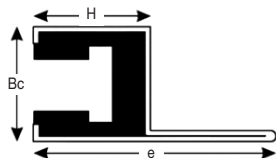

Standard Lengths : 2 Metres

Prices shown are for Galvanised Profile and Polyethylene Chain Guide.

For other sizes, grades or colours consult our Technical department.

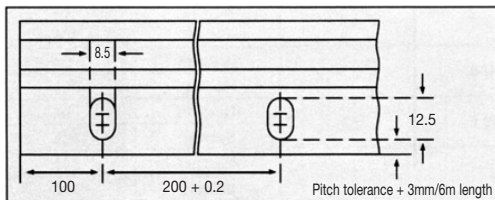

G for Galvanised Steel
S for Stainless Steel

EXAMPLE:

TAG V 15 - TDC 08B

The continuous mounting strip is provided with slotted holes for 8mm diameter screws at 200mm centres, allowing for adjustment.

| PART NUMBER | Pitch | d1 | Bc | Finished Size b | H | e | A | PRICE PER METRE |
|-------------|--------------|-------|----|--------------------|----|----|----|-----------------|
| TDC06B | 3/8" x 7/32" | 6.60 | 30 | 5.60 | 24 | 47 | 53 | £150.72 |
| TDC083 | 1/2" x 3/16" | 8.00 | 30 | 4.70 | 24 | 47 | 53 | £183.75 |
| TDC084 | 1/2" x 1/4" | 8.00 | 30 | 6.30 | 24 | 47 | 53 | £183.75 |
| TDC085 | 1/2" x 1/4" | 8.70 | 30 | 6.30 | 24 | 47 | 53 | £183.75 |
| TDC08B | 1/2" x 5/16" | 8.70 | 30 | 7.60 | 24 | 47 | 53 | £150.72 |
| TDC086 | 5/8" x 1/4" | 10.40 | 30 | 6.30 | 24 | 47 | 53 | £183.75 |
| TDC10B | 5/8" x 3/8" | 10.40 | 30 | 9.50 | 24 | 47 | 53 | £150.72 |
| TDC12B | 3/4" x 7/16" | 12.30 | 30 | 11.50 | 24 | 47 | 53 | £150.72 |

Unit 14, Foxwood Ind. Park, Foxwood Rd. Chesterfield, Derbyshire S41 9RN

Telephone +44(0)1246 268080 Fax +44(0)1246 260003



12.137

Pulleys & Belts TDC

Guide Rails for Simplex Chains Materials

TDC

STD : Polyethylene (U.H.M.W.Pe) Green DIN 8187

GR1 TDC

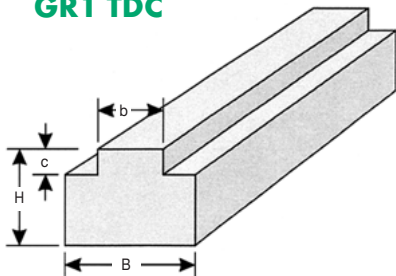

Standard Lengths : 2 Metres

Prices do not include 'C' Profiles.

For other sizes, grades or colours consult our Technical department.

without C Section Slots

DISCOUNTS

| | |
|----------|------------|
| 1 - 9 | List Price |
| 10 - 49 | - 20% |
| 50 - 100 | - 50% |

| PART NUMBER | Pitch | b | Finished Size | | H | PRICE PER METRE |
|---------------|---------------|------|---------------|-----|----|-----------------|
| | | | B | c | | |
| TDC04-1GR1 | 6 x 2.8mm | 2.6 | 10 | 1.0 | 10 | £43.49 |
| TDC05B-1GR1 | 8 x 3mm | 2.8 | 10 | 1.5 | 10 | £43.49 |
| TDC053-1GR1 | 3/8" x 5/32" | 3.8 | 15 | 1.5 | 10 | £45.08 |
| TDC06B-1GR1 | 3/8" x 7/32" | 5.5 | 15 | 1.5 | 10 | £45.08 |
| TDC081-1GR1 | 1/2" x 3.3mm | 3.0 | 12 | 1.5 | 10 | £44.05 |
| TDC084-1/1GR1 | 1/2 x 4.9mm | 4.6 | 17 | 2.0 | 10 | £45.82 |
| TDC083-1GR1 | 1/2" x 3/16" | 4.7 | 15 | 1.6 | 10 | £45.08 |
| TDC084-1/2GR1 | 1/2" x 1/4" | 6.2 | 20 | 2.1 | 10 | £46.82 |
| TDC08B-1GR1 | 1/2" x 5/16" | 7.5 | 20 | 2.2 | 10 | £46.82 |
| TDC086-1GR1 | 5/8" x 1/4" | 6.3 | 20 | 2.6 | 10 | £46.82 |
| TDC10B-1GR1 | 5/8" x 3/8" | 9.3 | 20 | 2.6 | 15 | £46.82 |
| TDC12B-1GR1 | 3/4" x 7/16" | 11.3 | 25 | 2.4 | 15 | £46.82 |
| TDC16B-1GR1 | 1" x 17mm | 16.5 | 40 | 4.3 | 15 | £60.77 |
| TDC20B-1GR1 | 1 1/4" x 3/4" | 19.0 | 45 | 4.2 | 15 | £63.26 |
| TDC24B-1GR1 | 1 1/2" x 1" | 24.7 | 60 | 5.5 | 15 | £70.82 |
| TDC28B-1GR1 | 1 3/4" x 31mm | 30.1 | 75 | 6.8 | 20 | £91.44 |
| TDC32B-1GR1 | 2" x 31mm | 30.1 | 80 | 7.7 | 20 | £94.72 |

Pulleys & Belts TDC

12.138



Unit 14, Foxwood Ind. Park, Foxwood Rd. Chesterfield, Derbyshire S41 9RN
Telephone +44(0)1246 268080 Fax +44(0)1246 260003

Materials **Guide Rails** for Simplex Chains

STD : Polyethylene (U.H.M.W.Pe) Green DIN 8187

TDC

GR1C TDC

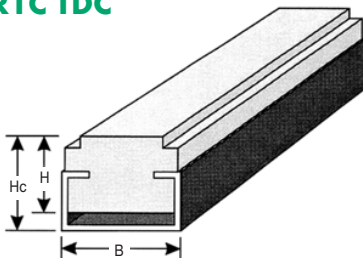

Standard Lengths : 2 Metres

Prices do not include 'C' Profiles.

For other sizes, grades or colours consult our Technical department.

DISCOUNTS

| | |
|----------|------------|
| 1 - 9 | List Price |
| 10 - 49 | - 20% |
| 50 - 100 | - 50% |

with C Section Slots

| PART NUMBER | Pitch | Finished Size | | | C Profile | PRICE PER METRE |
|--------------|---------------|---------------|----|----|-----------|-----------------|
| | | B | H | Hc | | |
| TDC083-10C/A | 1/2" x 3/16" | 20 | 10 | 15 | TDC 2010 | £83.03 |
| TDC084-10C | 1/2" x 1/4" | 20 | 10 | 15 | TDC 2010 | £83.03 |
| TDC08B-10C/A | 1/2" x 5/16" | 20 | 10 | 15 | TDC 2010 | £83.03 |
| TDC083-10C/B | 1/2" x 3/16" | 17 | 15 | 17 | TDC 2010 | £83.03 |
| TDC085-10C | 1/2" x 1/4" | 17 | 15 | 17 | TDC 2010 | £83.03 |
| TDC08B-10C/B | 1/2" x 5/16" | 17 | 15 | 17 | TDC 2010 | £83.03 |
| TDC086-10C | 5/8" x 1/4" | 17 | 15 | 17 | TDC 2010 | £83.03 |
| TDC10B-10C | 5/8" x 3/8" | 17 | 15 | 17 | TDC 2010 | £83.03 |
| TDC12B-10C/A | 3/4" x 7/16" | 20 | 15 | 17 | TDC 2010 | £83.03 |
| TDC12B-10C/B | 3/4" x 7/16" | 24 | 15 | 18 | TDC 2812 | £83.03 |
| TDC16B-10C | 1" x 17mm | 24 | 15 | 18 | TDC 2812 | £88.98 |
| TDC20B-10C | 1 1/4" x 3/4" | 28 | 15 | 18 | TDC 2812 | £90.95 |
| TDC24B-10C | 1 1/2" x 1mm | 33 | 25 | 30 | TDC 3818 | £105.44 |
| TDC28B-10C | 1 3/4" x 31" | 38 | 25 | 30 | TDC 3818 | £109.63 |
| TDC32B-10C | 2" x 31" | 38 | 25 | 30 | TDC 3818 | £109.63 |

Unit 14, Foxwood Ind. Park, Foxwood Rd. Chesterfield, Derbyshire S41 9RN

Telephone +44(0)1246 268080 Fax +44(0)1246 260003



12.139

Guide Rails for Duplex Chains *Materials*

TDC

STD : Polyethylene (U.H.M.W.Pe) Green DIN 8187

GR2 TDC

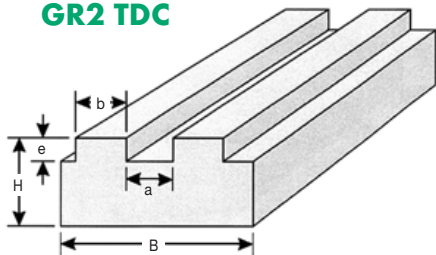

Standard Lengths : 2 Metres

For other sizes, grades or colours
consult our Technical department.

Pulleys & Belts TDC

for Duplex Chains

DISCOUNTS

| | |
|----------|------------|
| 1 - 9 | List Price |
| 10 - 49 | - 20% |
| 50 - 100 | - 50% |

| PART NUMBER | Pitch | Finished Size | | | | PRICE PER METRE | |
|-------------|---------------|---------------|------|----|-----|-----------------|---------|
| | | a | b | B | e | H | |
| TDC05B-2 | 8 x 3mm | 2.6 | 2.8 | 16 | 1.5 | 10 | £48.55 |
| TDC06B-2 | 3/8" x 7/32" | 4.6 | 5.5 | 25 | 1.5 | 10 | £51.56 |
| TDC08B-2 | 1/2" x 5/16" | 6.2 | 7.5 | 35 | 2.2 | 10 | £51.56 |
| TDC10B-2 | 5/8" x 3/5" | 7.0 | 9.3 | 40 | 2.6 | 10 | £51.56 |
| TDC12B-2 | 3/4" x 7/16" | 7.8 | 11.3 | 45 | 2.4 | 10 | £51.56 |
| TDC16B-2 | 1" x 17mm | 15.0 | 16.5 | 48 | 4.3 | 15 | £51.56 |
| TDC20B-2 | 1 1/4" x 3/4" | 17.0 | 19.0 | 55 | 4.2 | 15 | £71.30 |
| TDC24B-2 | 1 1/2" x 1" | 22.6 | 24.7 | 72 | 5.5 | 20 | £92.40 |
| TDC28B-2 | 1 3/4" x 31mm | 28.8 | 30.1 | 89 | 6.8 | 25 | £119.13 |
| TDC32B-2 | 2" x 31mm | 27.8 | 30.1 | 88 | 7.7 | 30 | £133.60 |

12.140



Unit 14, Foxwood Ind. Park, Foxwood Rd. Chesterfield, Derbyshire S41 9RN
Telephone +44(0)1246 268080 Fax +44(0)1246 260003

Materials **Guide Rails** for Triplex Chains

STD : Polyethylene (U.H.M.W.Pe) Green DIN 8187

TDC

GR3 TDC

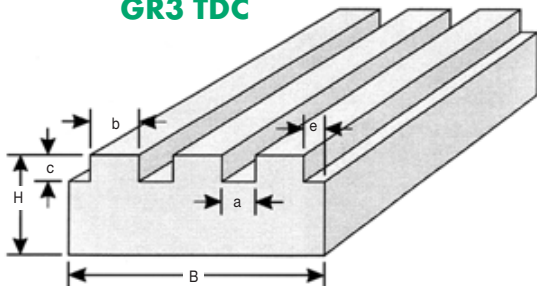

Standard Lengths : 2 Metres

**For other sizes, grades or colours
consult our Technical department.**

Pulleys & Belts TDC

DISCOUNTS

| | |
|----------|------------|
| 1 - 9 | List Price |
| 10 - 49 | - 20% |
| 50 - 100 | - 50% |

for Triplex Chains

| PART NUMBER | Pitch | a | b | e | Finished Size B | c | H | PRICE PER METRE |
|-------------|--------------|------|------|-------|-----------------|-----|----|-----------------|
| TDC06B-3 | 3/8" x 7/32" | 4.7 | 5.5 | 4.55 | 35 | 1.5 | 10 | £57.91 |
| TDC08B-3 | 1/2" x 5/16" | 6.5 | 7.4 | 4.40 | 44 | 2.2 | 10 | £60.91 |
| TDC10B-3 | 5/8" x 3/8" | 7.4 | 9.2 | 5.30 | 53 | 2.6 | 10 | £63.99 |
| TDC12B-3 | 3/4" x 7/16" | 8.9 | 11.2 | 5.90 | 62 | 3.0 | 10 | £66.93 |
| TDC16B-3 | 1" x 17mm | 15.4 | 16.5 | 11.85 | 104 | 3.5 | 15 | £99.05 |

Unit 14, Foxwood Ind. Park, Foxwood Rd. Chesterfield, Derbyshire S41 9RN

Telephone +44(0)1246 268080 Fax +44(0)1246 260003



12.141

Guide Rails for Simplex Chains Materials

TDC

STD : Polyethylene (U.H.M.W.Pe) Green DIN 8187

GL1b TDC

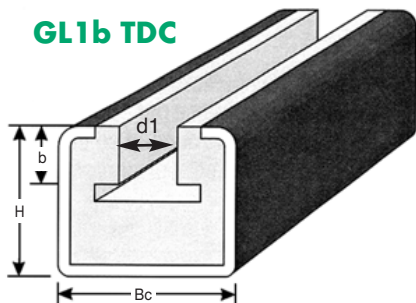

Standard Lengths : 2 Metres

Prices do not include 'C' Profiles.

For other sizes, grades or colours consult our Technical department.

Pulleys & Belts TDC

for Simplex Chains

DISCOUNTS

| | |
|----------|------------|
| 1 - 9 | List Price |
| 10 - 49 | - 20% |
| 50 - 100 | - 50% |

| PART NUMBER | Pitch | d1 | Finished Size Bc | b | H | PRICE PER METRE |
|-------------|---------------|------|------------------|------|----|-----------------|
| TDC053-10U | 3/8" x 5/32" | 6.6 | 30 | 3.8 | 24 | £100.24 |
| TDC06B-10U | 3/8" x 7/32" | 6.6 | 30 | 5.6 | 24 | £100.24 |
| TDC083-10U | 1/2" x 3/16" | 8.0 | 30 | 4.7 | 24 | £100.24 |
| TDC084-10U | 1/2" x 1/4" | 8.0 | 30 | 6.3 | 24 | £100.24 |
| TDC085-10U | 1/2" x 1/4" | 8.7 | 30 | 6.3 | 24 | £100.24 |
| TDC08B-10U | 1/2" x 5/16" | 8.7 | 30 | 7.6 | 24 | £100.24 |
| TDC086-10U | 5/8" x 1/4" | 10.4 | 30 | 6.3 | 24 | £100.24 |
| TDC10B-10U | 5/8" x 3/8" | 10.4 | 30 | 9.5 | 24 | £100.24 |
| TDC12B-10U | 3/4" x 7/16" | 12.3 | 30 | 11.5 | 24 | £100.24 |
| TDC16B-10U | 1" x 17mm | 16.1 | 45 | 16.5 | 40 | £135.98 |
| TDC20B-10U | 1 1/4" x 3/4" | 19.3 | 45 | 17.5 | 40 | £135.98 |

12.142



Unit 14, Foxwood Ind. Park, Foxwood Rd. Chesterfield, Derbyshire S41 9RN
Telephone +44(0)1246 268080 Fax +44(0)1246 260003

Materials **Guide Rails** for Simplex Chains

STD : Polyethylene (U.H.M.W.Pe) Green DIN 8187

TDC

GL1X TDC

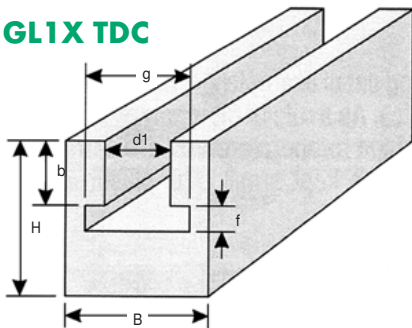

Standard Lengths : 2 Metres

Prices do not include 'C' Profiles.

For other sizes, grades or colours consult our Technical department.

DISCOUNTS

| | |
|----------|------------|
| 1 - 9 | List Price |
| 10 - 49 | - 20% |
| 50 - 100 | - 50% |

for Simplex Chains

| PART NUMBER | Pitch | Finished Size | | | PRICE PER METRE | | | |
|--------------|---------------|---------------|------|----|-----------------|------|----|---------|
| | | d1 | g | B | f | b | H | |
| TDC053-1GL1X | 3/8" x 5/32" | 6.6 | 9.3 | 20 | 4.2 | 3.8 | 25 | £60.91 |
| TDC06B-1GL1X | 3/8" x 7/32" | 6.6 | 9.3 | 20 | 4.3 | 5.6 | 25 | £60.91 |
| TDC083-1GL1X | 1/2" x 3/16" | 8.0 | 10.8 | 20 | 3.6 | 4.7 | 25 | £60.91 |
| TDC084-1GL1X | 1/2" x 1/4" | 8.0 | 11.8 | 24 | 4.9 | 6.3 | 30 | £68.49 |
| TDC085-1GL1X | 1/2" x 1/4" | 8.7 | 12.8 | 24 | 5.0 | 6.3 | 30 | £68.49 |
| TDC08B-1GL1X | 1/2" x 5/16" | 8.7 | 12.8 | 24 | 5.1 | 7.6 | 30 | £68.49 |
| TDC086-1GL1X | 5/8" x 1/4" | 10.4 | 15.4 | 30 | 5.4 | 6.3 | 30 | £75.21 |
| TDC10B-1GL1X | 5/8" x 3/8" | 10.4 | 15.4 | 30 | 5.3 | 9.5 | 35 | £80.46 |
| TDC12B-1GL1X | 3/4" x 7/16" | 12.3 | 16.9 | 40 | 6.0 | 11.5 | 35 | £93.12 |
| TDC16B-1GL1X | 1" x 17mm | 16.1 | 24.4 | 40 | 9.9 | 16.5 | 45 | £106.68 |
| TDC20B-1GL1X | 1 1/4" x 3/4" | 19.3 | 27.5 | 50 | 11.8 | 19.4 | 50 | £130.97 |
| TDC24B-1GL1X | 1 1/2" x 1" | 25.7 | 36.5 | 60 | 14.9 | 25.2 | 60 | £168.82 |
| TDC28B-1GL1X | 1 3/4" x 31mm | 28.3 | 41.5 | 60 | 18.1 | 30.8 | 70 | £188.60 |
| TDC32B-1GL1X | 2" x 31mm | 28.3 | 41.5 | 70 | 22.2 | 30.8 | 75 | £225.18 |

Unit 14, Foxwood Ind. Park, Foxwood Rd. Chesterfield, Derbyshire S41 9RN

Telephone +44(0)1246 268080 Fax +44(0)1246 260003



12.143

Pulleys & Belts TDC